

COMELETRIC

Specialized rotary and control switches

CONTROL SWITCHES STANDARD ELECTRIC DIAGRAMS



Models Available Index

Available for:

Series: FR10	Models: Stayput positions: C101 - C103 - C104 - C130 - C138 - C141 - C152 - C154 - C154P C161 - C168 - C172 - C182 - C182P - C189 - C190 - C192 - C192L Spring return positions: C105 - C109 - C115 - C129 - C143 - C148 - C149 - C157 - C157P C167 - C187 - C192LM - C196 Maintained Action Contact: C118 - C139
------------------------	--

Series: R20	Models: Stayput positions: R106 - R102 - R103 - R108 - R108B - R131 - R141 - R162 R176 - R193 - R193L Spring return positions: R121 - R109 - R123 - R125 - R132 - R160 - R193LM Maintained Action Contact: R120
-----------------------	---

Series: R16	Models: Stayput positions: R601 - R602 - R603 - R605 Spring return positions: R601M - R602M - R603M - R605M Maintained Action Contact: R608
-----------------------	--

Series: FRMC 6	Models: Stayput positions: C601 - C602 - C602K - C603 - C609 - C610 - C616 - C617 - C618 Spring return positions: C607 - C608 - C61 Maintained Action Contact: N.A.
--------------------------	--

Series: FRMC 6 IP20	Models: Stayput positions: C701 - C701E - C702 - C702K - C704 - C708 - C709 Spring return positions: C701M - C702M Maintained Action Contact: N.A.
-------------------------------	---

Series: FRMC 2000	Models: Stayput positions: C201 - C202 Spring return positions: C203 - C204 Maintained Action Contact: N.A.
-----------------------------	--

The maximum number of packets varies depending on the series and model.
The maximum number of the packets is stated in the catalogue and in the dimensional drawing of the various models.

Ordering Method

In this catalogue you may find some electric diagrams and instructions for composing independently order codes of standard switches. For special diagrams or diagrams which are not present in this catalogue use the form on page 24. Schemes of this catalogue and their use in the codes are applicable only to the series of switches shown on the previous page. They **are not applicable to the series FR10 62 - FR10 68 - FR10 adf - FRB10 - FRMC 6 80 - FRM10 - DR20 - LR20 - FRMM 6 FRMM 2000.**

These diagrams and the composition of these codes are available in their respective catalogues.

Product Coding

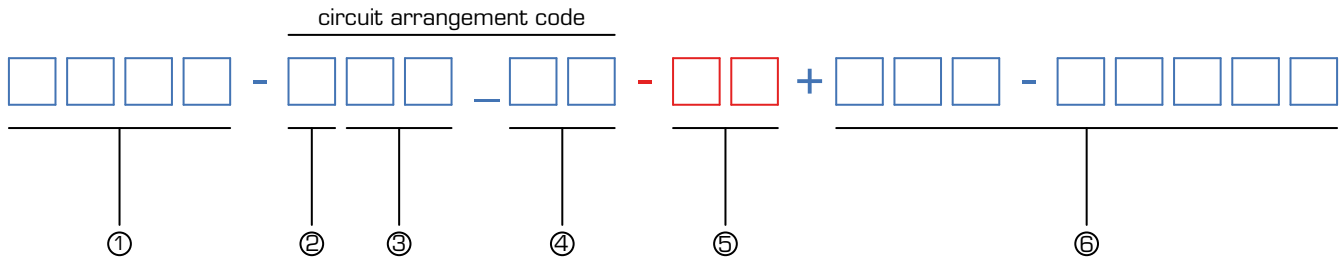

① Model Number of the switch.

Model number means the assembly and construction form unique for each switch, this reference identifies the series, the type of switch, if it has fixed positions or the spring return, the type of knob, if it is provided with control key, key lock or padlock facility. This model number is indicated in the catalogues along with its dimensional drawing and panel cutout. For switches with spring return, the model number is also indicated in the catalogues. It is considered switch with spring return the type where there is a single fixed position. Where there are two or more fixed positions, it is considered as the model number of the switch with all fixed positions. In the previous page there is a list, for the various series of model numbers of the most common types.

② n° of Positions.

This is the reference of the number of positions that the switch should have, from a minimum of 2 up to a maximum of 8, for the series of switches shown in this catalogue. The movements of the knob can be of 45 ° or 90 °.

③ n° of Packets.

As number of packets, it is means by how many isolating discs should be made the switch.

The number of packets affects the number of poles required. Generally in each packet you have a contact NORMALLY OPEN and a contact NORMALLY CLOSED, but this can vary depending on the wiring diagram. In this catalogue electric diagrams with 12 packets of contacts are shown, but this is only an indication, each kind of switch can be realized by a minimum of 1 packets to the maximum foreseen by its model number. In each reference catalogue, next to the table of lengths, it is shown the maximum number of packets suitable for that specific model number.

one Packet

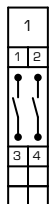

④ n° of Electric diagram

This number, along with the number of positions, is an indication of the electric diagram of the switch required.

It includes the wiring diagram and the movement of the knob, in reference to the diagrams shown below. It has no specific meaning, it is just a sequence number that is used to represent a specific scheme of the switch assembly.

⑤ n° of Locking Program

This number is only used in key operated switches, key lock switches, padlockable switches or with removable knob. It represents the position in which the switch can be locked.

The locking of the switch key operated or with key lock device is made by means of extraction of the key from the same. In the models with removable knob, locking position is the same as for those with the key, instead for the padlockable types it is the position where it is given the opportunity to pull the pin to enter the lock. The reference table for the program number lock is on page 23 of this catalogue and must conform to the movement of the handle provided in the frame of reference of the switch.

⑥ n° Escutcheon Plate

This code is referred to the shape, type and engraving of the Frontplate.

On page 21 of this catalogue, all instructions to create codes of the frontplates used frequently.

Standard Development Diagrams

2 Positions

Double-throw Switch without "0" position 2 positions switching 90° with electrically isolated contacts

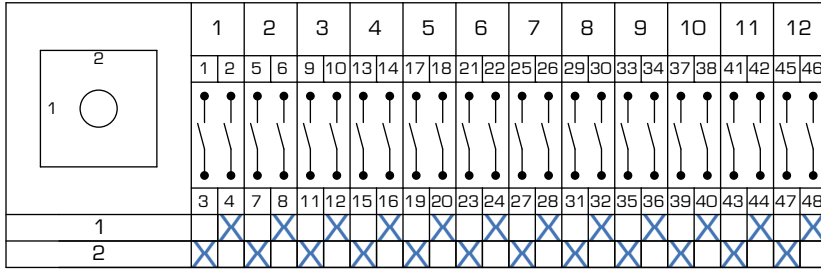

N° Packets	Circuit Arrangement
1	201_01
2	202_01
3	203_01
4	204_01
5	205_01
6	206_01
7	207_01
8	208_01
9	209_01
10	210_01
12	212_01
14	214_01
16	216_01
18	218_01
20	220_01
22	222_01
24	224_01
30	230_01
32	232_01
36	236_01

Double-throw Switch without "0" position 2 positions switching 90° with electrically isolated contacts

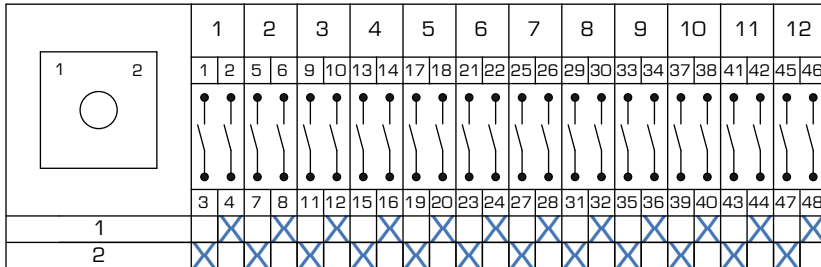

N° Packets	Circuit Arrangement
1	201_02
2	202_02
3	203_02
4	204_02
5	205_02
6	206_02
7	207_02
8	208_02
9	209_02
10	210_02
12	212_02
14	214_02
16	216_02
18	218_02
20	220_02
22	222_02
24	224_02
30	230_02
32	232_02
36	236_02

Double-throw Switch without "0" position 2 positions switching 90° with electrically isolated contacts

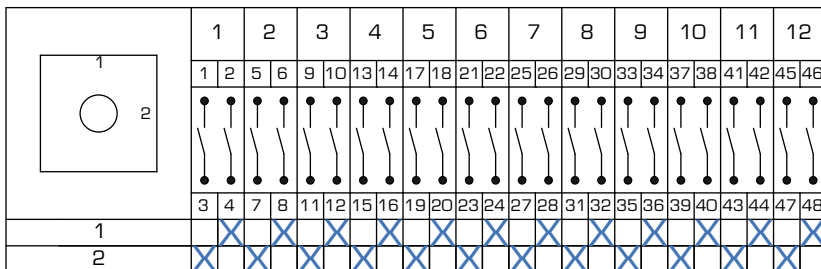

N° Packets	Circuit Arrangement
1	201_03
2	202_03
3	203_03
4	204_03
5	205_03
6	206_03
7	207_03
8	208_03
9	209_03
10	210_03
12	212_03
14	214_03
16	216_03
18	218_03
20	220_03
22	222_03
24	224_03
30	230_03
32	232_03
36	236_03

Double-throw Switch without "0" position 2 positions switching 90° with 1 input and 2 outputs. on each packet.

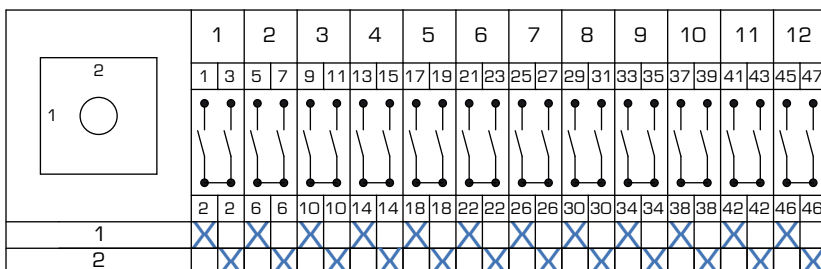

N° Packets	Circuit Arrangement
1	201_07
2	202_07
3	203_07
4	204_07
5	205_07
6	206_07
7	207_07
8	208_07
9	209_07
10	210_07
12	212_07
14	214_07
16	216_07
18	218_07
20	220_07
22	222_07
24	224_07
30	230_07
32	232_07
36	236_07

Double-throw Switch without "0" position 2 positions switching 90° with 1 input and 2 outputs. on each packet.

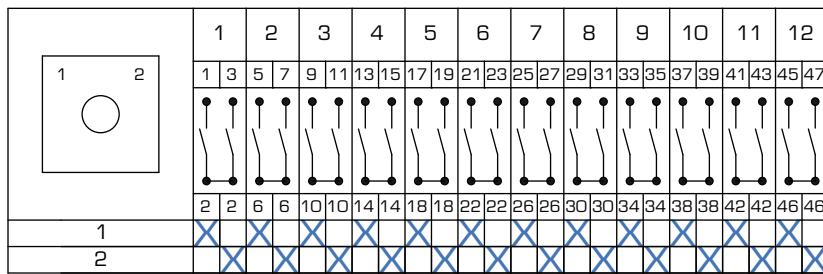

N° Packets	Circuit Arrangement
1	201_08
2	202_08
3	203_08
4	204_08
5	205_08
6	206_08
7	207_08
8	208_08
9	209_08
10	210_08
12	212_08
14	214_08
16	216_08
18	218_08
20	220_08
22	222_08
24	224_08
30	230_08
32	232_08
36	236_08

Double-throw Switch without "0" position 2 positions switching 90° with 1 input and 2 outputs. on each packet.

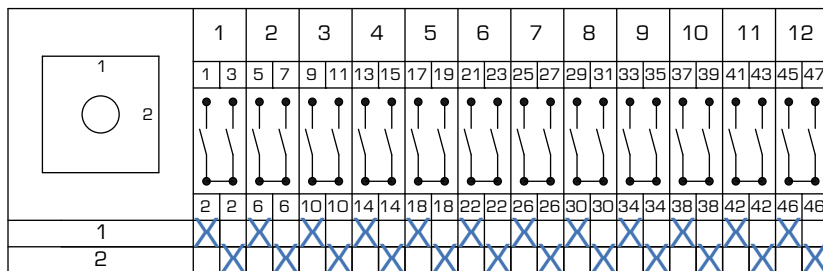

N° Packets	Circuit Arrangement
1	201_09
2	202_09
3	203_09
4	204_09
5	205_09
6	206_09
7	207_09
8	208_09
9	209_09
10	210_09
12	212_09
14	214_09
16	216_09
18	218_09
20	220_09
22	222_09
24	224_09
30	230_09
32	232_09
36	236_09

2 Positions OFF - ON with 90° switching angle

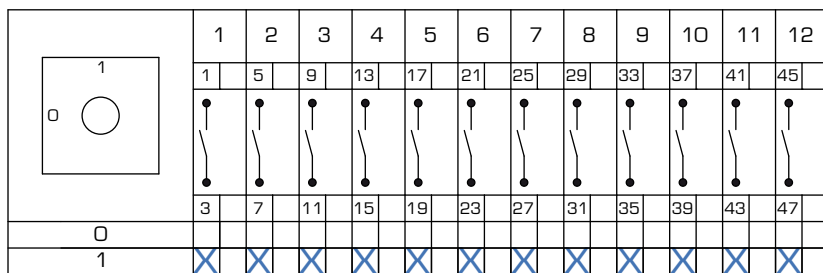

N° Packets	Circuit Arrangement
1	201_19
2	202_19
3	203_19
4	204_19
5	205_19
6	206_19
7	207_19
8	208_19
9	209_19
10	210_19
12	212_19
14	214_19
16	216_19
18	218_19
20	220_19
22	222_19
24	224_19
30	230_19
32	232_19
36	236_19

2 Positions OFF - ON with 90° switching angle

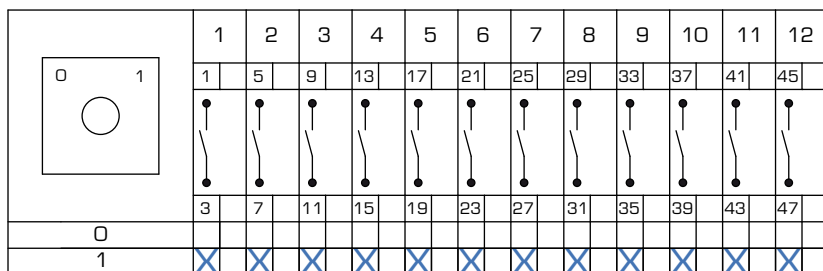

N° Packets	Circuit Arrangement
1	201_20
2	202_20
3	203_20
4	204_20
5	205_20
6	206_20
7	207_20
8	208_20
9	209_20
10	210_20
12	212_20
14	214_20
16	216_20
18	218_20
20	220_20
22	222_20
24	224_20
30	230_20
32	232_20
36	236_20

2 Positions ON - OFF with 90° switching angle

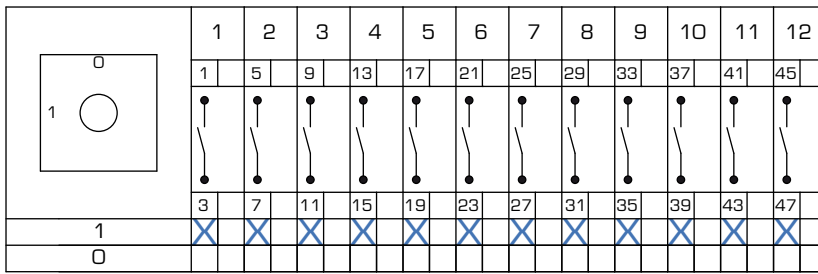

N° Packets	Circuit Arrangement
1	201_22
2	202_22
3	203_22
4	204_22
5	205_22
6	206_22
7	207_22
8	208_22
9	209_22
10	210_22
12	212_22
14	214_22
16	216_22
18	218_22
20	220_22
22	222_22
24	224_22
30	230_22
32	232_22
36	236_22

2 Positions ON - OFF with 90° switching angle

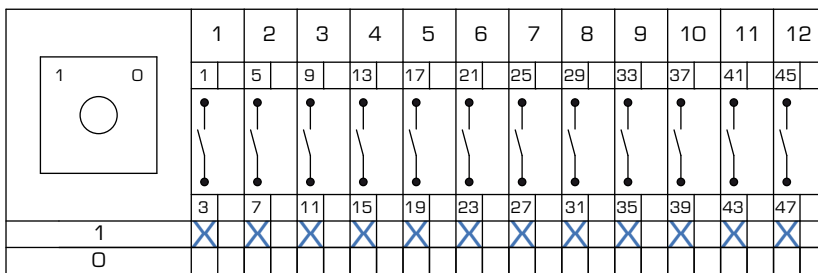

N° Packets	Circuit Arrangement
1	201_23
2	202_23
3	203_23
4	204_23
5	205_23
6	206_23
7	207_23
8	208_23
9	209_23
10	210_23
12	212_23
14	214_23
16	216_23
18	218_23
20	220_23
22	222_23
24	224_23
30	230_23
32	232_23
36	236_23

Double-throw Switch without "0" position 2 positions switching 45° with electrically isolated contacts

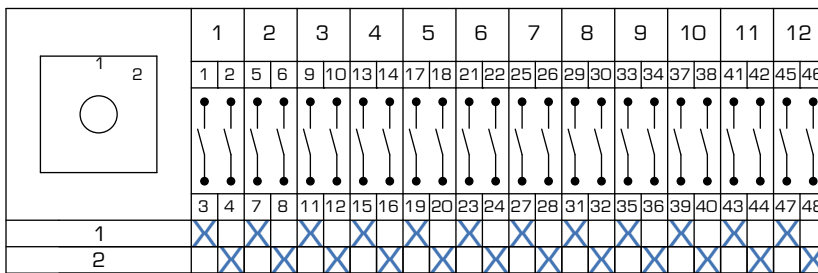

N° Packets	Circuit Arrangement
1	201_32
2	202_32
3	203_32
4	204_32
5	205_32
6	206_32
7	207_32
8	208_32
9	209_32
10	210_32
12	212_32
14	214_32
16	216_32
18	218_32
20	220_32
22	222_32
24	224_32
30	230_32
32	232_32
36	236_32

Double-throw Switch without "0" position 2 positions switching 45° with electrically isolated contacts

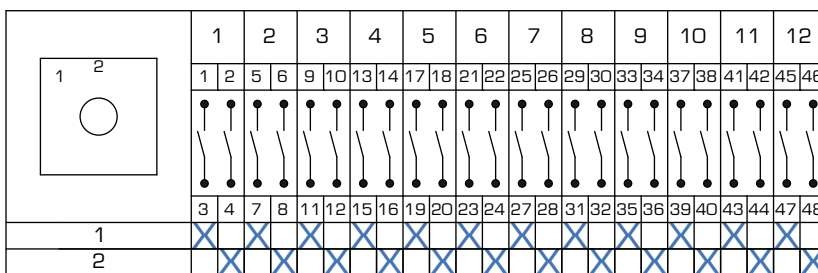

N° Packets	Circuit Arrangement
1	201_72
2	202_72
3	203_72
4	204_72
5	205_72
6	206_72
7	207_72
8	208_72
9	209_72
10	210_72
12	212_72
14	214_72
16	216_72
18	218_72
20	220_72
22	222_72
24	224_72
30	230_72
32	232_72
36	236_72

3 Positions

Double-throw Switch with "0" position 3 positions switching 45° with electrically isolated contacts

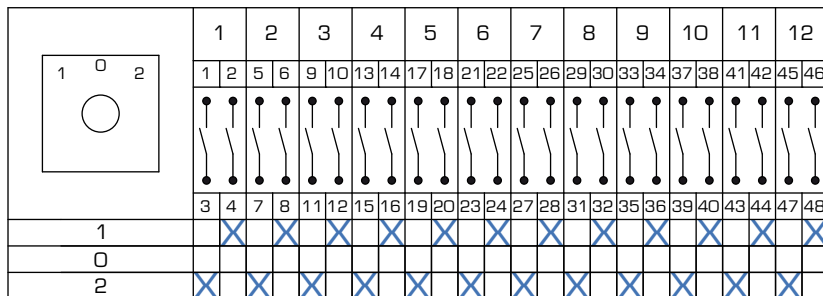

N° Packets	Circuit Arrangement
1	301_01
2	302_01
3	303_01
4	304_01
5	305_01
6	306_01
7	307_01
8	308_01
9	309_01
10	310_01
12	312_01
14	314_01
16	316_01
18	318_01
20	320_01
22	322_01
24	324_01
30	330_01
32	332_01
36	336_01

Double-throw Switch with "0" position 3 positions switching 45° 1 input 2 outputs in each packet.

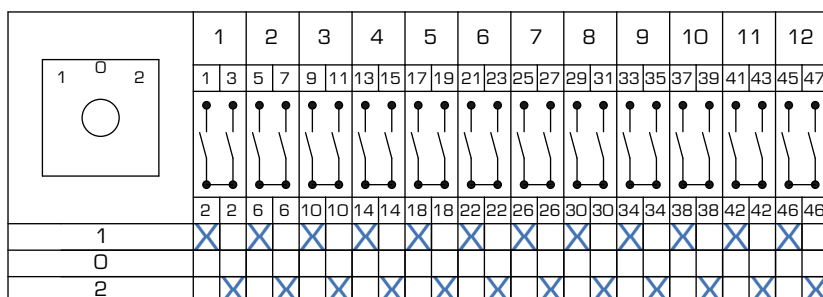

N° Packets	Circuit Arrangement
1	301_03
2	302_03
3	303_03
4	304_03
5	305_03
6	306_03
7	307_03
8	308_03
9	309_03
10	310_03
12	312_03
14	314_03
16	316_03
18	318_03
20	320_03
22	322_03
24	324_03
30	330_03
32	332_03
36	336_03

Multistep Switch without "0" position 3 positions switching 45° 1 input and 3 outputs in each packet.

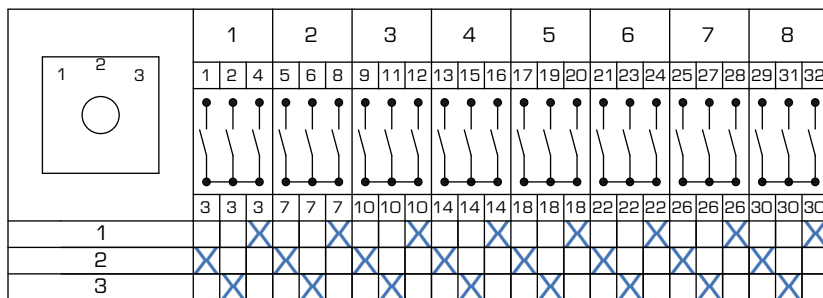

N° Packets	Circuit Arrangement
1	301_04
2	302_04
3	303_04
4	304_04
5	305_04
6	306_04
7	307_04
8	308_04
9	309_04
10	310_04
12	312_04
14	314_04
16	316_04
18	318_04
20	320_04
22	322_04
24	324_04
30	330_04
32	332_04
36	336_04

Double-throw Switch with "0" position 3 positions switching 90° 1 input 2 outputs in each packet.

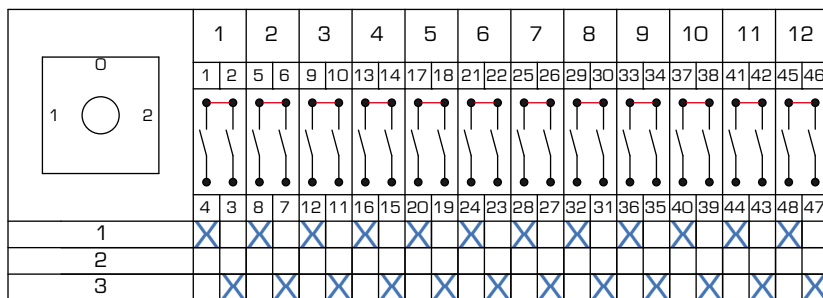

N° Packets	Circuit Arrangement
1	301_25
2	302_25
3	303_25
4	304_25
5	305_25
6	306_25
7	307_25
8	308_25
9	309_25
10	310_25
12	312_25
14	314_25
16	316_25
18	318_25
20	320_25
22	322_25
24	324_25
30	330_25
32	332_25
36	336_25

Double-throw Switch with "0" position 3 positions switching 45° with electrically isolated contacts

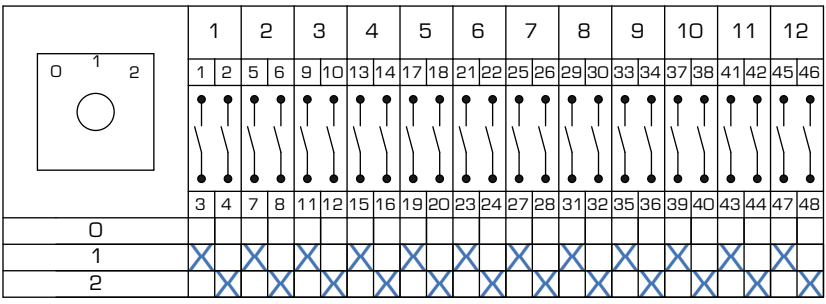

N° Packets	Circuit Arrangement
1	301_16
2	302_16
3	303_16
4	304_16
5	305_16
6	306_16
7	307_16
8	308_16
9	309_16
10	310_16
12	312_16
14	314_16
16	316_16
18	318_16
20	320_16
22	322_16
24	324_16
30	330_16
32	332_16
36	336_16

Multistep Switch 3 positions switching 45° with electrically isolated contacts

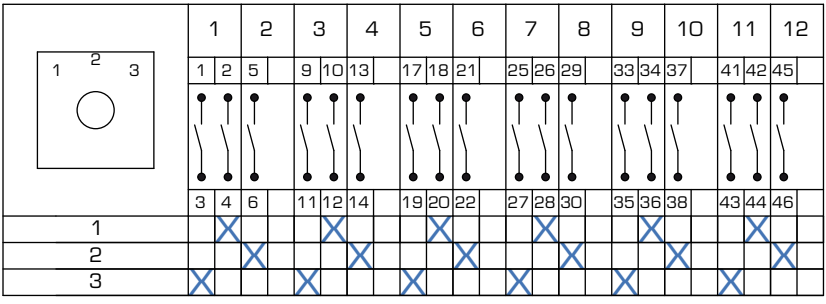

N° Packets	Circuit Arrangement
2	302_19
4	304_19
6	306_19
8	308_19
10	310_19
12	312_19
14	314_19
16	316_19
18	318_19
20	320_19
22	322_19
24	324_19
26	326_19
28	328_19
30	330_19
32	332_19
34	334_19
36	336_19

Double-throw Switch with "0" position 3 positions switching 45° with spring return from left to central position with electrically isolated contacts

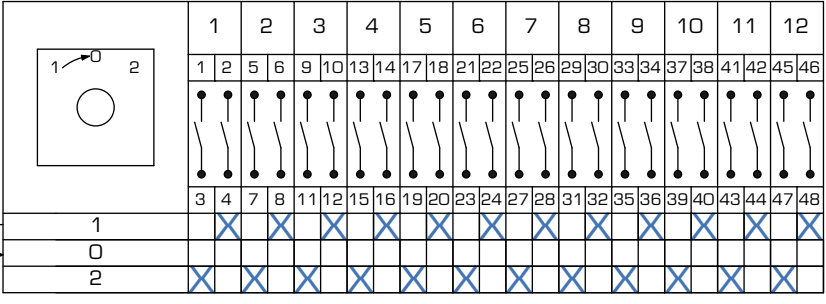

N° Packets	Circuit Arrangement
1	301_12
2	302_12
3	303_12
4	304_12
5	305_12
6	306_12
7	307_12
8	308_12
9	309_12
10	310_12
12	312_12

Double-throw Switch with "0" position 3 positions switching 45° with spring return from right to central position with electrically isolated contacts

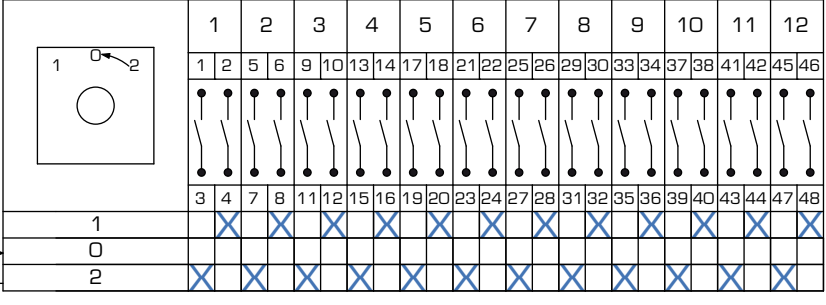

N° Packets	Circuit Arrangement
1	301_20
2	302_20
3	303_20
4	304_20
5	305_20
6	306_20
7	307_20
8	308_20
9	309_20
10	310_20
12	312_20

Multistep Switch 3 positions switching 45° with electrically isolated contacts

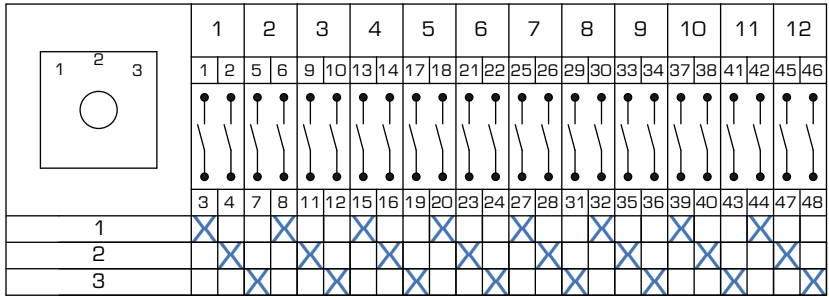

N° Packets	Circuit Arrangement
3	303_78
6	306_78
9	309_78
12	312_78
15	315_78
18	318_78
21	321_78
24	324_78
27	327_78
30	330_78
33	333_78
36	336_78

Multistep Switch 3 positions switching 45° with make before break electrically isolated contacts

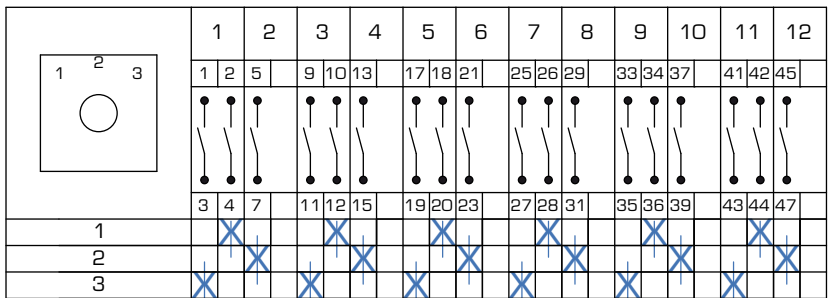

N° Packets	Circuit Arrangement
2	302_76
4	304_76
6	306_76
8	308_76
10	310_76
12	312_76
14	314_76
16	316_76
18	318_76
20	320_76

Multistep Switch 3 positions switching 45° with 1 input 3 output make before break contacts in each packet.

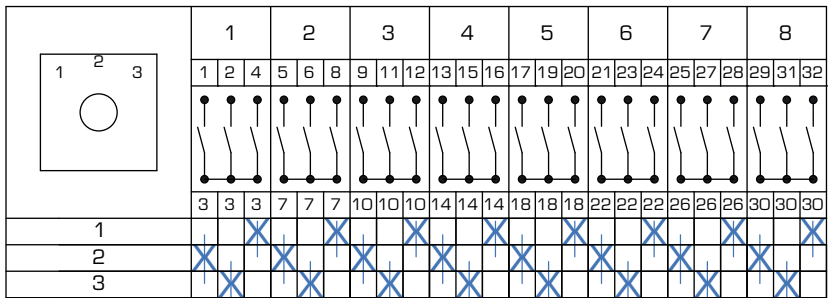

N° Packets	Circuit Arrangement
1	301_05
2	302_05
3	303_05
4	304_05
5	305_05
6	306_05
7	307_05
8	308_05
9	309_05
10	310_05
12	312_05
14	314_05
16	316_05
18	318_05
20	320_05

Multistep Switch 3 positions switching 45° with electrically isolated contacts

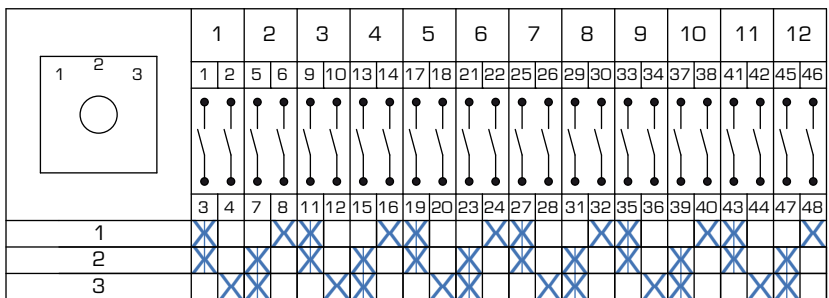

N° Packets	Circuit Arrangement
1	301_84
2	302_84
3	303_84
4	304_84
5	305_84
6	306_84
7	307_84
8	308_84
9	309_84
10	310_84
12	312_84
14	314_84
16	316_84
18	318_84
20	320_84
22	322_84
24	324_84
30	330_84
32	332_84
36	336_84

4 Positions

Multistep Switch without "O" 4 positions switching 45° with electrically isolated contacts

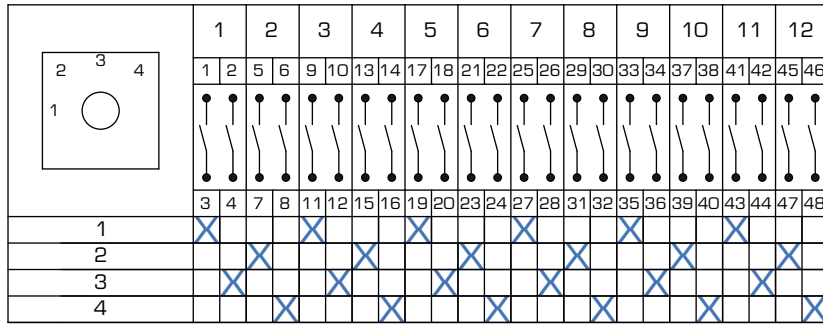

N° Packets	Circuit Arrangement
2	402_03
4	404_03
6	406_03
8	408_03
10	410_03
12	412_03
14	414_03
16	416_03
18	418_03
20	420_03
22	422_03
24	424_03
26	426_03
28	428_03
30	430_03
32	432_03
34	434_03
36	436_03

Multistep Switch with "O" 4 positions switching 45° with electrically isolated contacts

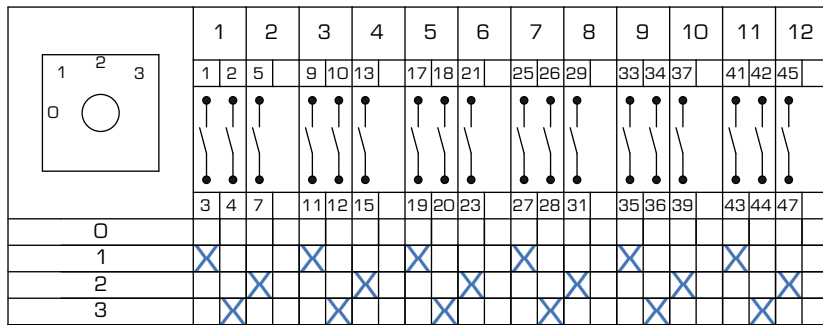

N° Packets	Circuit Arrangement
2	402_08
4	404_08
6	406_08
8	408_08
10	410_08
12	412_08
14	414_08
16	416_08
18	418_08
20	420_08
22	422_08
24	424_08
26	426_08
28	428_08
30	430_08
32	432_08
34	434_08
36	436_08

Multistep Switch without "O" 4 positions switching 45°

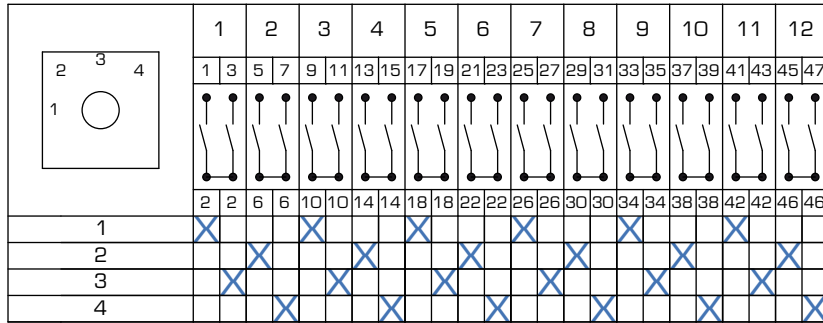

N° Packets	Circuit Arrangement
2	402_07
4	404_07
6	406_07
8	408_07
10	410_07
12	412_07
14	414_07
16	416_07
18	418_07
20	420_07
22	422_07
24	424_07
26	426_07
28	428_07
30	430_07
32	432_07
34	434_07
36	436_07

Multistep Switch without "O" 4 positions switching 90° with electrically isolated contacts

AVAILABLE ONLY IN R20 AND FR10 SERIES

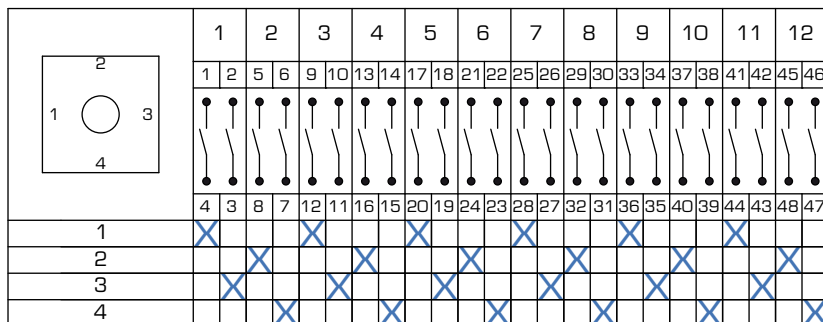

N° Packets	Circuit Arrangement
2	402_41
4	404_41
6	406_41
8	408_41
10	410_41
12	412_41
14	414_41
16	416_41
18	418_41
20	420_41
22	422_41
24	424_41
26	426_41
28	428_41
30	430_41
32	432_41
34	434_41
36	436_41

Multistep Switch without "0" 4 positions switching 45° with make before break electrically isolated contacts

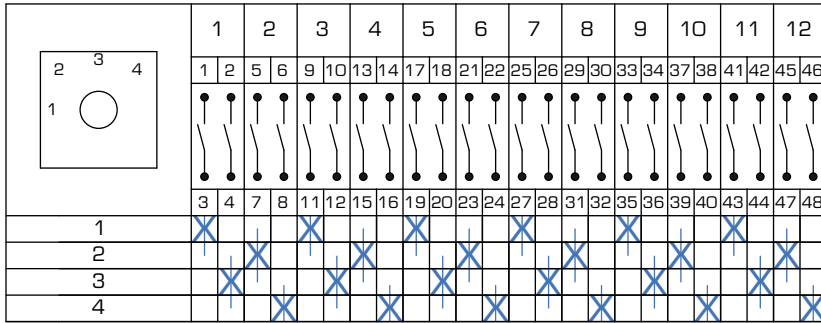

N° Packets	Circuit Arrangement
2	402_45
4	404_45
6	406_45
8	408_45
10	410_45
12	412_45
14	414_45
16	416_45
18	418_45
20	420_45

Multistep Switch with "0" 4 positions switching 45° with make before break electrically isolated contacts

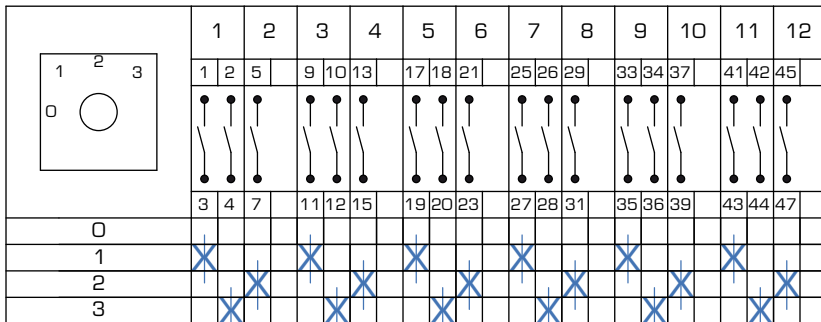

N° Packets	Circuit Arrangement
2	402_47
4	404_47
6	406_47
8	408_47
10	410_47
12	412_47
14	414_47
16	416_47
18	418_47
20	420_47

Multistep Switch without "0" 4 positions switching 45° with electrically isolated contacts

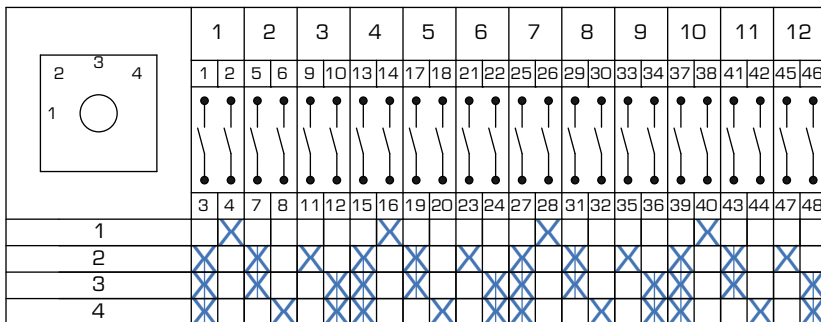

N° Packets	Circuit Arrangement
3	403_46
6	406_46
9	409_46
12	412_46
15	415_46
18	418_46
21	421_46
24	424_46
27	427_46
30	430_46
33	433_46
36	436_46

Switch without "0" 4 positions switching 90° with electrically isolated contacts

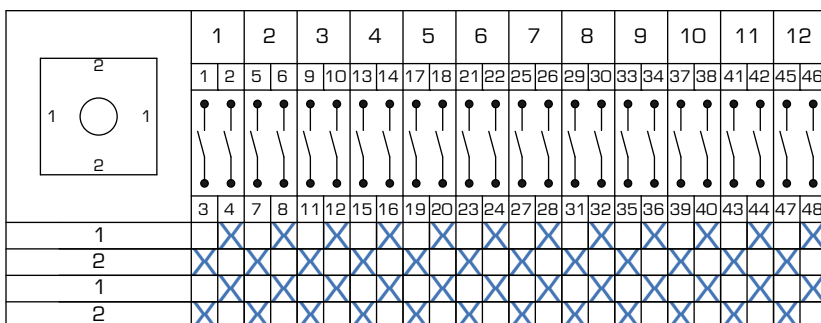

N° Packets	Circuit Arrangement
1	401_01
2	402_01
3	403_01
4	404_01
5	405_01
6	406_01
7	407_01
8	408_01
9	409_01
10	410_01
12	412_01
14	414_01
16	416_01
18	418_01
20	420_01
22	422_01
24	424_01
30	430_01
32	432_01
36	436_01

Switch without "0" 4 positions switching 45°, 3 stayput positions + 1 spring return from pos. 4 to pos. 3 with electrically isolated contacts

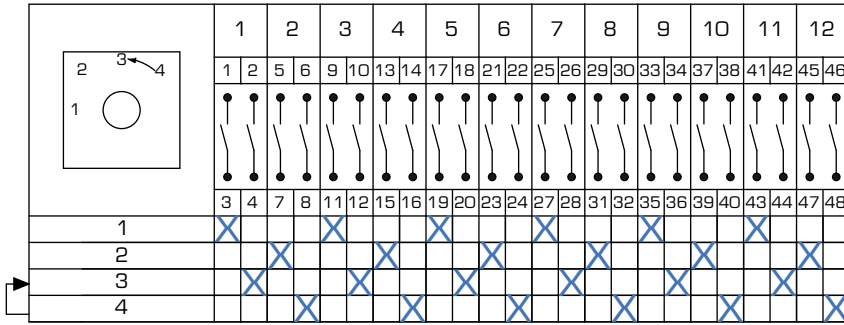

N° Packets	Circuit Arrangement
2	402_24
4	404_24
6	406_24
8	408_24
10	410_24
12	412_24
14	414_24
16	416_24

Switch with "0" 4 positions switching 45°, 3 stayput positions + 1 spring return from pos. 1 to pos. 0 with electrically isolated contacts

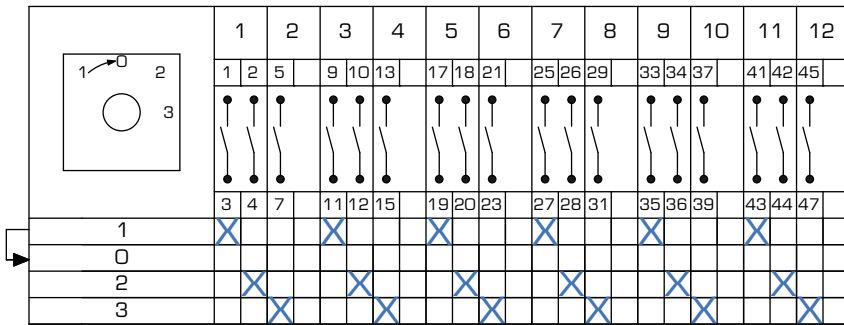

N° Packets	Circuit Arrangement
2	402_57
4	404_57
6	406_57
8	408_57
10	410_57
12	412_57
14	414_57
16	416_57

Switch with "0" 4 positions switching 45°, 2 stayput positions + 2 spring return from pos. 2 and to pos. 3 to pos. 0 with electrically isolated contacts

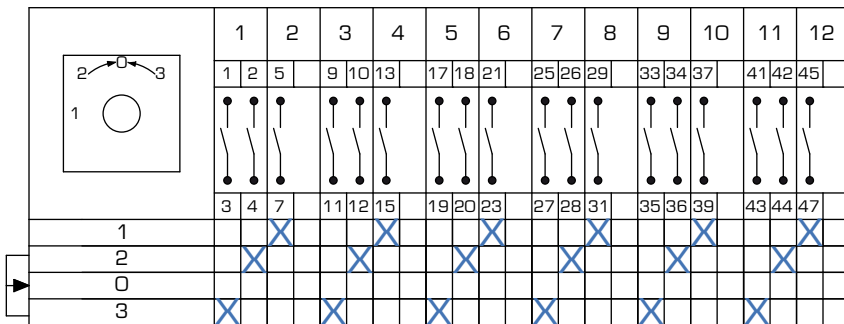

N° Packets	Circuit Arrangement
2	402_58
4	404_58
6	406_58
8	408_58
10	410_58
12	412_58
14	414_58
16	416_58

Multistep Switch without "0" 4 positions switching 45° with electrically isolated contacts

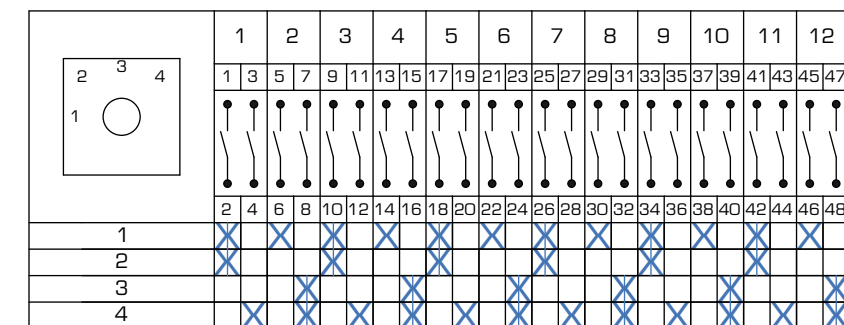

N° Packets	Circuit Arrangement
2	402_53
4	404_53
6	406_53
8	408_53
10	410_53
12	412_53
14	414_53
16	416_53
18	418_53
20	420_53

5 Positions

Multistep Switch with "0" 5 positions switching 45° with electrically isolated contacts

AVAILABLE ONLY THE R20 AND FR10 SERIES

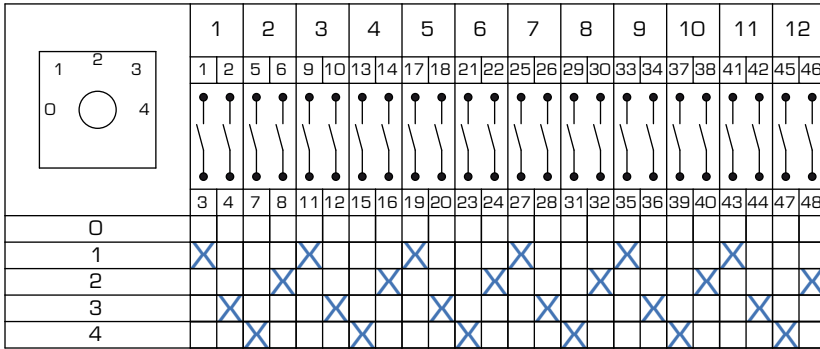

N° Packets	Circuit Arrangement
3	503_20
6	506_20
9	509_20
12	512_20
15	515_20
18	518_20
21	521_20
24	524_20
27	527_20
30	530_20
33	533_20
36	536_20

Multistep Switch without "0" 4 positions switching 45° with electrically isolated contacts

AVAILABLE ONLY THE R20 AND FR10 SERIES

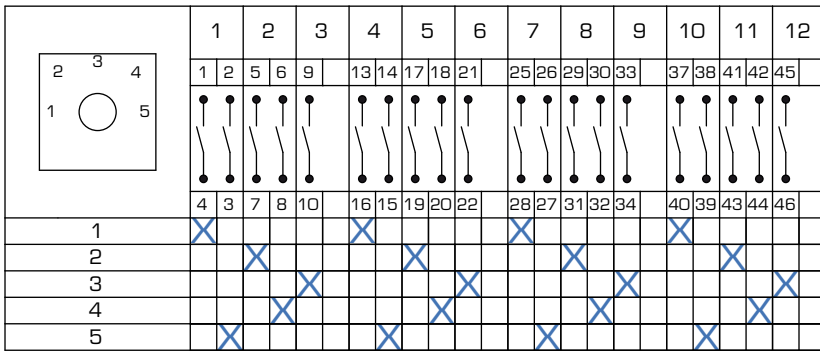

N° Packets	Circuit Arrangement
3	503_18
6	506_18
9	509_18
12	512_18
15	515_18
18	518_18
21	521_18
24	524_18
27	527_18
30	530_18
33	533_18
36	536_18

5 positions Multistep Switch with 2 "0" positions switching 45° with electrically isolated contacts

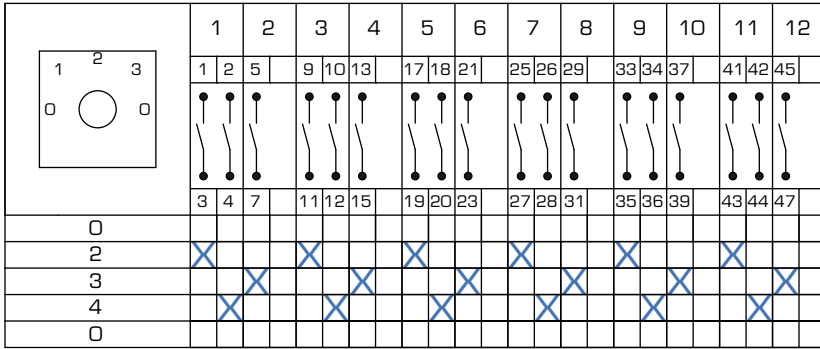

N° Packets	Circuit Arrangement
2	502_19
4	504_19
6	506_19
8	508_19
10	510_19
12	512_19
14	514_19
16	516_19
18	518_19
20	520_19

Multistep Switch with "0" 5 positions switching 45° with electrically isolated contacts

AVAILABLE ONLY THE R20 AND FR10 SERIES

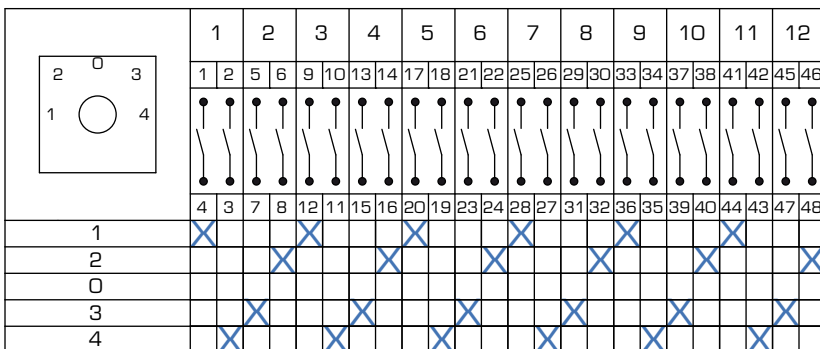

N° Packets	Circuit Arrangement
2	502_22
4	504_22
6	506_22
8	508_22
10	510_22
12	512_22
14	514_22
16	516_22
18	518_22
20	520_22

Multistep Switch with "0" 7 positions switching 45° with electrically isolated contacts

AVAILABLE ONLY THE R20 AND FR10 SERIES

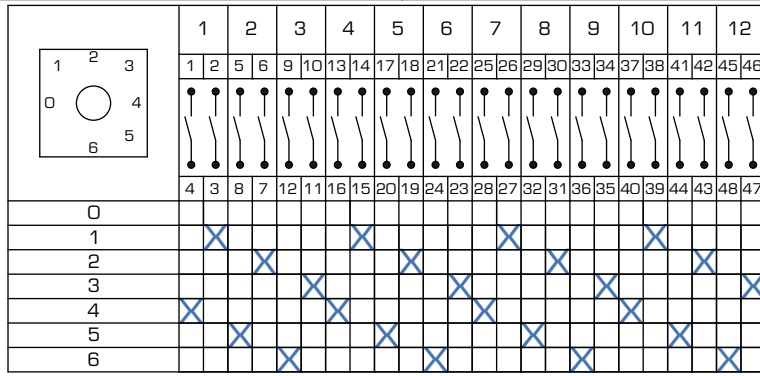

N° Packets	Circuit Arrangement
3	703_03
6	706_03
9	709_03
12	712_03
15	715_03
18	718_03
21	721_03
24	724_03
27	727_03
30	730_03
33	733_03
36	736_03

Multistep Switch without "0" 4 positions switching 45°

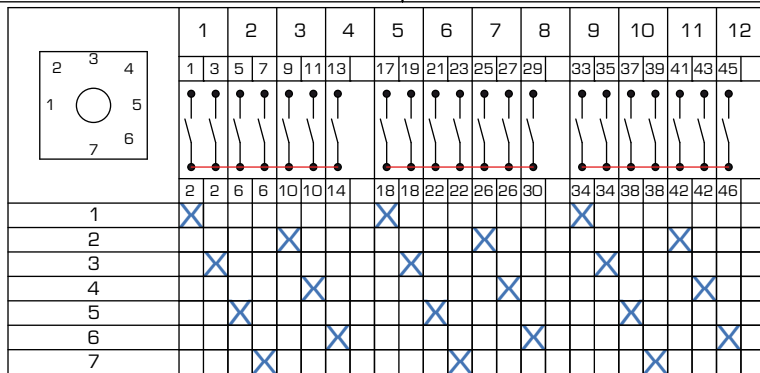

N° Packets	Circuit Arrangement
3	703_04
6	706_04
9	709_04
12	712_04
15	715_04
18	718_04
21	721_04
24	724_04
27	727_04
30	730_04
33	733_04
36	736_04

8 Positions

Multistep Switch without "0" 8 positions switching 45° with electrically isolated contacts

AVAILABLE ONLY THE R20 AND FR10 SERIES

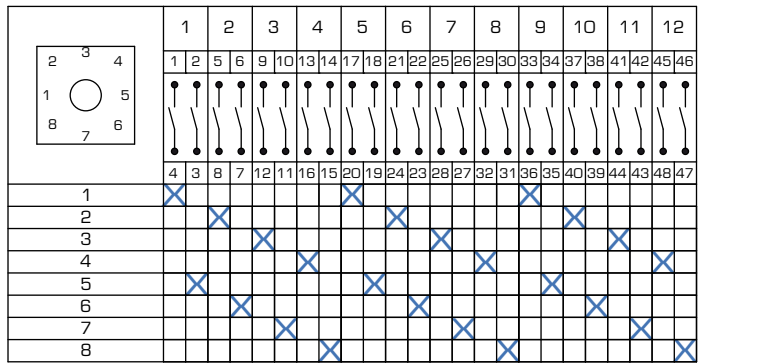

N° Packets	Circuit Arrangement
4	804_01
8	808_01
12	812_01
16	816_01
20	820_01
24	824_01
28	828_01
32	832_01
36	836_01

Multistep Switch without "0" 8 positions switching 45°

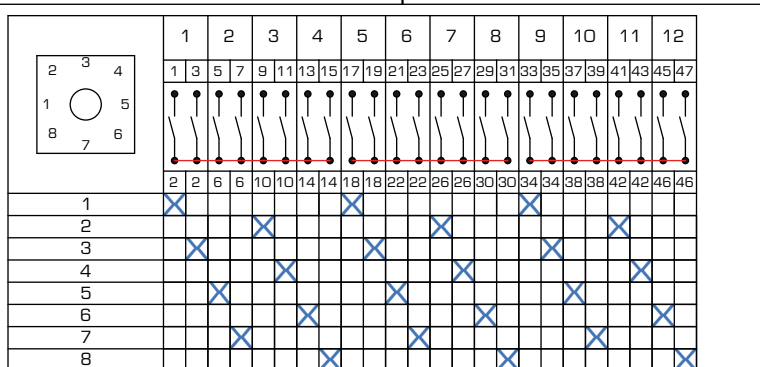

N° Packets	Circuit Arrangement
4	804_02
8	808_02
12	812_02
16	816_02
20	820_02
24	824_02
28	828_02
32	832_02
36	836_02

Instruments Switches

The Circuit arrangement number has to be mentioned in the product code (point 2-3-4).

VOLTMETER SWITCH : 2 wire Single phase or d.c.		VOLTMETER SWITCH: 4 wire Two Phase or Two separate D-C circuits	
Circuit Arrangement n° 202V		Circuit Arrangement n° 302V	

VOLTMETER SWITCH : 3 Phase voltages measurements.		VOLTMETER SWITCH: 1 Phase to Phase and 3 Phase voltages measurements.	
Circuit Arrangement n° 4A02		Circuit Arrangement n° 4B03	

VOLTMETER SWITCH : 3 Phase to Phase voltages measurements.		VOLTMETER SWITCH : 1 Phase voltage and 3 Phase to Phase voltages measurements.	
Circuit Arrangement n° 4E03		Circuit Arrangement n° 4F04	

VOLTMETER SWITCH : 3 Phase to Phase voltages measurements and 3 Phase voltages measurements.		VOLTMETER SWITCH : 3 Phase to Phase voltages measurements in Two 3 Phase circuits.	
Circuit Arrangement n° 8C08			

AMMETER SWITCH : For 1 Phase current measurement with "0" position.

Circuit Arrangement n° **2G02**

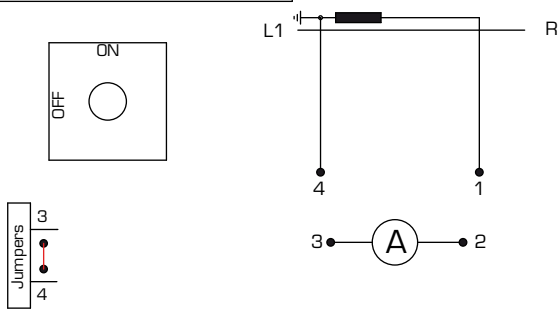

AMMETER SWITCH : 3 positions , 3 Current measurements with 2 transformers without "0" position.

Circuit Arrangement n° **302-A01**

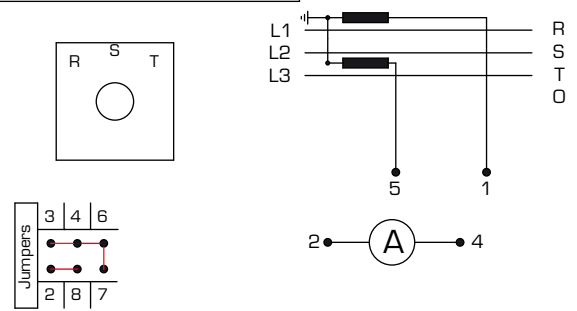

AMMETER SWITCH : 3 positions , 3 Current measurements with 3 transformers without "0" position.

Circuit Arrangement n° **303_A01**

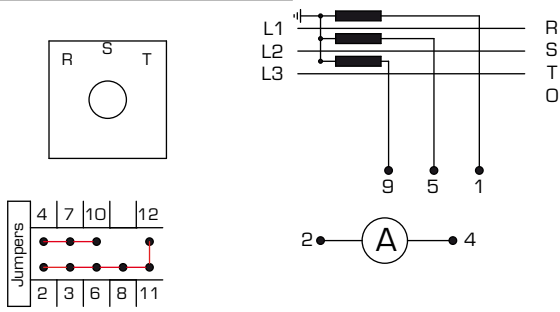

AMMETER SWITCH : 4 positions , 3 Current measurements with 2 transformers.

Circuit Arrangement n° **4D03**

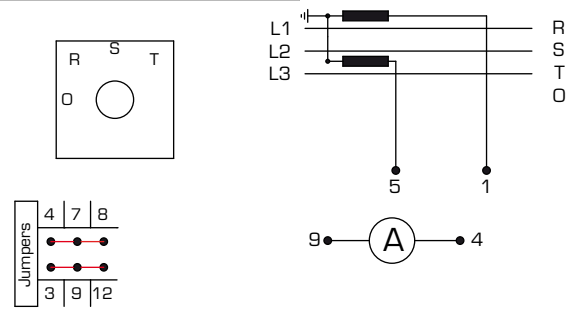

AMMETER SWITCH : 4 positions , 3 Current measurements with 3 transformers.

Circuit Arrangement n° **4H04**

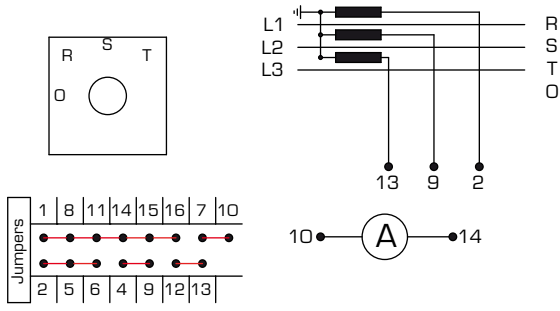

AMMETER SWITCH : 4 positions , 3 Current measurement , 2 current transformers with transducer.

Circuit Arrangement n° **405_A01**

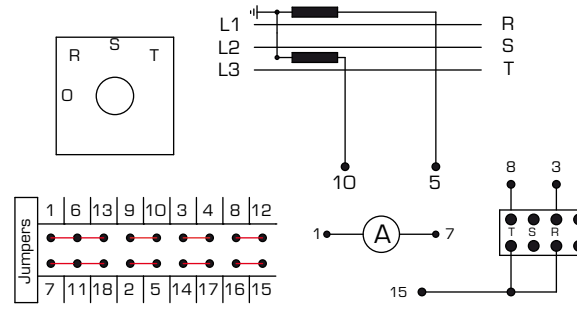

AMMETER SWITCH : 4 positions , 3 Current measurements ,3 current transformers with transducer.

Circuit Arrangement n° **405_A02**

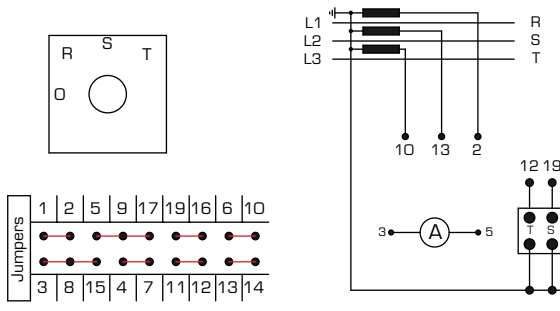

AMMETER - VOLTMETER SWITCH : 4 positions , 3 Phase to Phase and 3 current transformers measurements.

Circuit Arrangement n° **407_AV01**

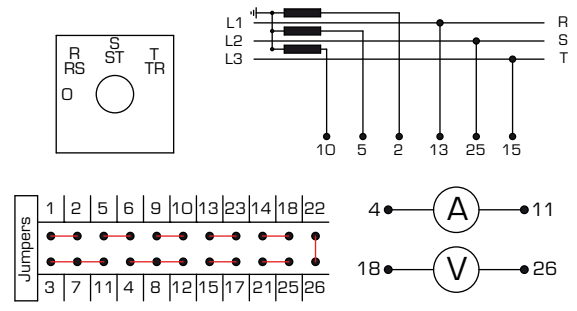

Circuit Breaker Control Switches

The Circuit arrangement number has to be mentioned in the product code (point 2-3-4).

The Diagram can be used only on switches with spring return or with maintained action contacts, mentioned on page of "MODELS AVAIIABLE INDEX".

The Circuit Breaker Control Switches are Spring return switches "TRIP>O<CLOSE". They are used widely to operate the high and medium voltage circuit breakers. Often additional contacts are needed for use as alarms or indicators, which maintain the configuration of the last order given (TYPICALLY CALLED "MAINTAINED ACTION CONTACTS").

For this application the flag mechanical indicator on the frontal escutcheon plate often is used.

The Flag mechanical indicator shows the last operation, **RED** For CLOSE and **GREEN** For TRIP, when the switch is in LOCK position the color is **BLACK**.

The Type FRMC 6 - FRMC 6 IP20 and th FRMC 2000 are available only with spring return, but without maintained action contacts and flag mechanical indicator.

They are Mainly used for opening and closing of circuit breakers or disconnectors in little mimic panels, in LCC and in mosaic tile system panels.

TYPE OF MOUNTING:

Generally Circuit Breaker Control Switches are panel mounting.

For Panel drilling see model Drawing.

SWITCHING ANGLE:

For spring return switches the switching angle is 45 degrees.

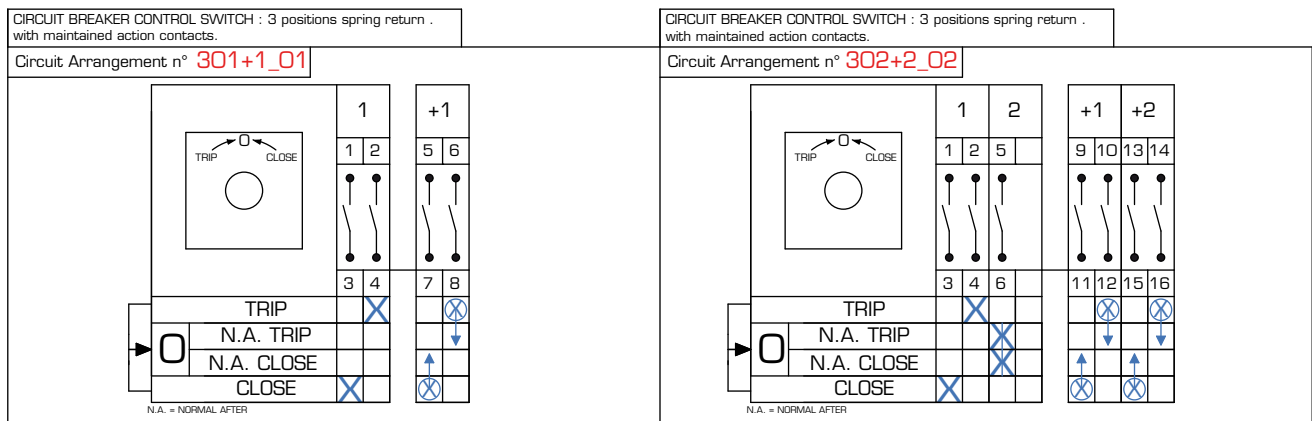
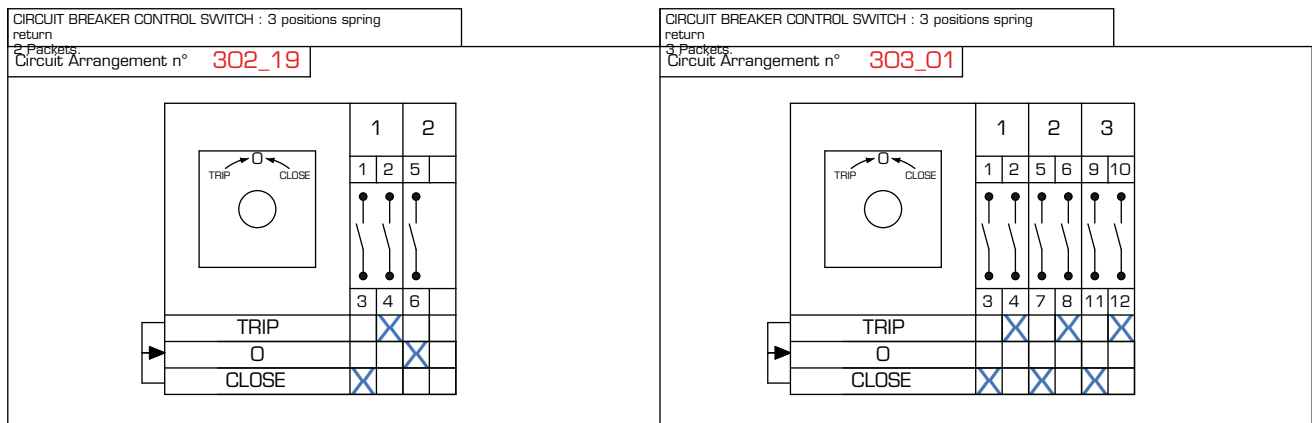
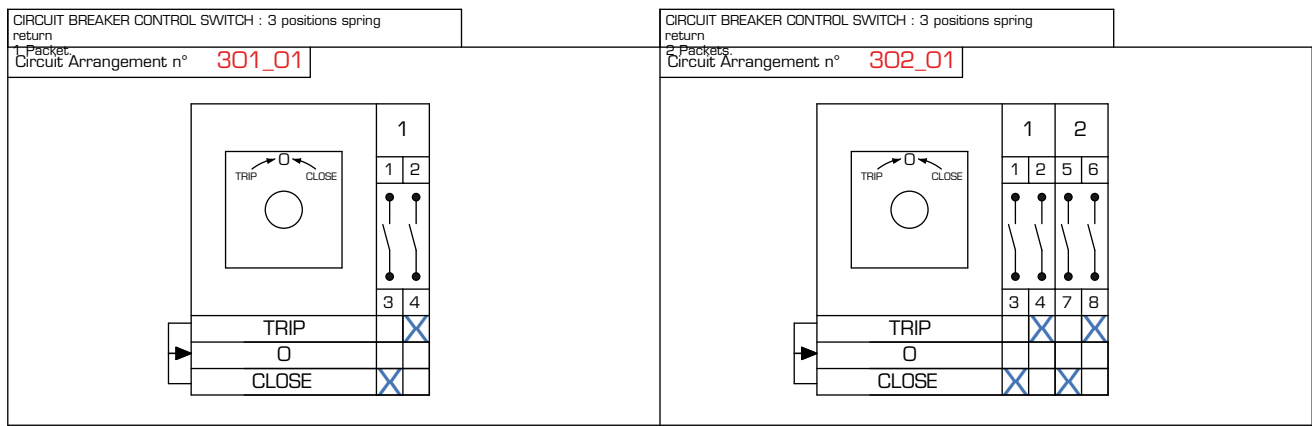

CIRCUIT BREAKER CONTROL SWITCH : 3 positions spring return . with maintained action contacts.

Circuit Arrangement n° 303+2_02

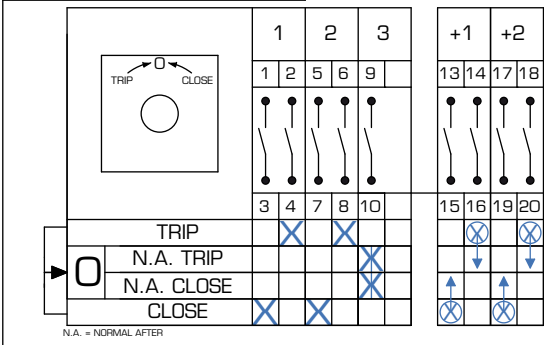

CIRCUIT BREAKER CONTROL SWITCH : 3 positions spring return . with maintained action contacts.

Circuit Arrangement n° 304+2_02

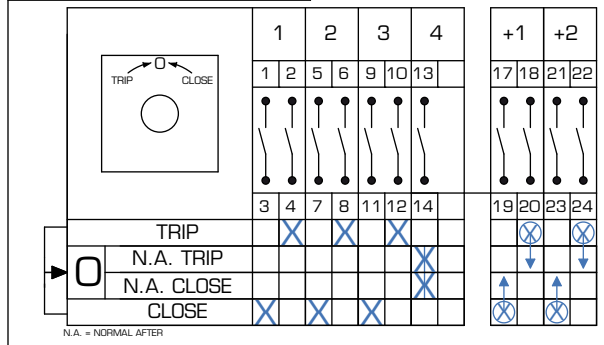

CIRCUIT BREAKER CONTROL SWITCH: 3 positions spring return and 1 stayput position for lock, with maintained action contacts.

Circuit Arrangement n° 402+2_01

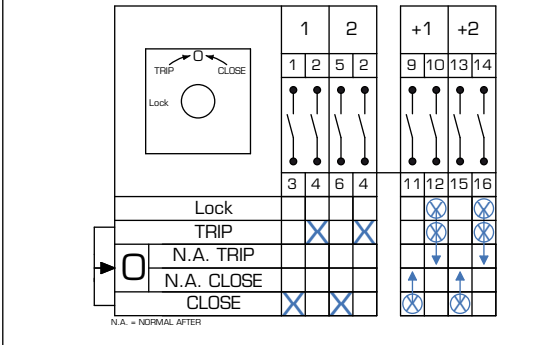

CIRCUIT BREAKER CONTROL SWITCH: 3 positions spring return and 1 stayput position for lock, with maintained action contacts.

Circuit Arrangement n° 402+3_03

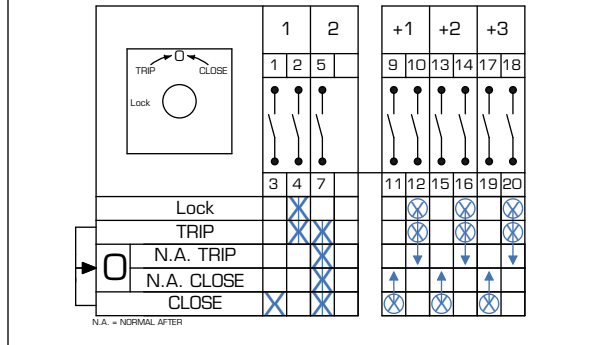

CIRCUIT BREAKER CONTROL SWITCH: 3 positions spring return and 1 stayput position for lock, with maintained action contacts.

Circuit Arrangement n° 403+2_04

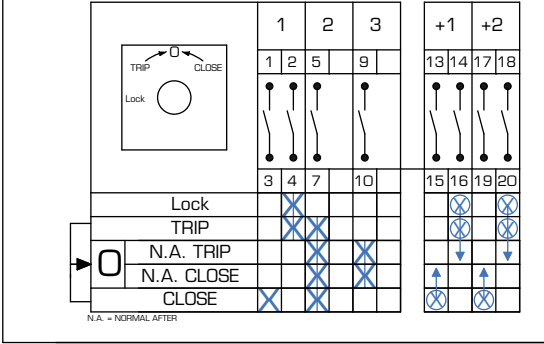

CIRCUIT BREAKER CONTROL SWITCH: 3 positions spring return and 1 stayput position for lock, with maintained action contacts.

Circuit Arrangement n° 404+4_03

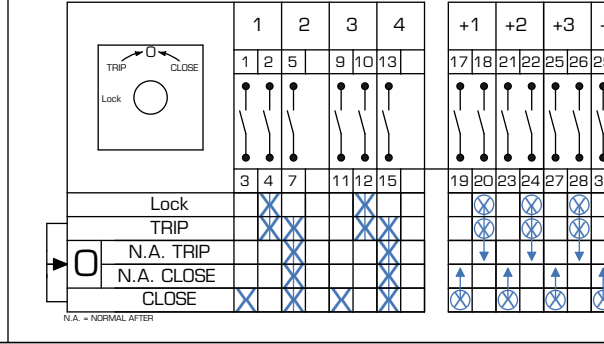

CIRCUIT BREAKER CONTROL SWITCH: 3 positions spring return and 1 stayput position for lock, with maintained action contacts.

Circuit Arrangement n° 403+1_05

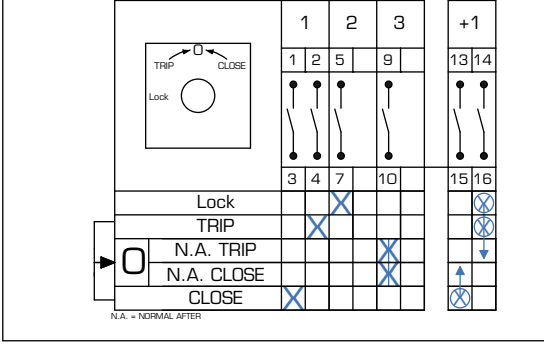

CIRCUIT BREAKER CONTROL SWITCH: 3 positions spring return and 1 stayput position for lock, with maintained action contacts.

Circuit Arrangement n° 402+1_06

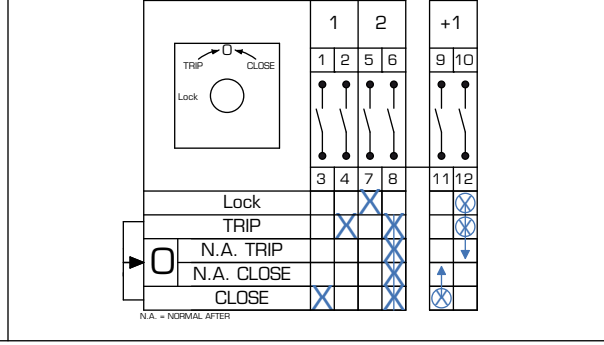

Other Standard Diagrams.

The Circuit arrangement number has to be mentioned in the product code (point 2-3-4).

STOP - START CONTROL SWITCH : 3 positions spring return .
Per Contactor Control.

Circuit Arrangement n° **3M02**

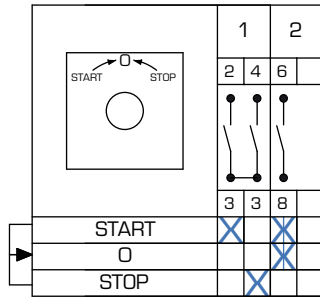

STOP - START CONTROL SWITCH : 3 positions spring return from START to ON position.

Circuit Arrangement n° **S303_55**

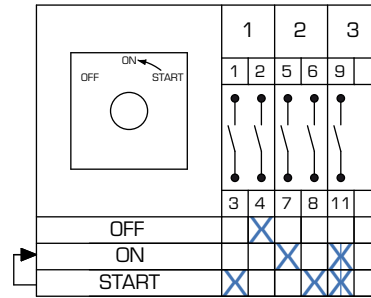

STOP START CONTROL SWITCH : 5 positions 3 Stayput and 2 spring return for inverter control.

Circuit Arrangement n° **5N02**

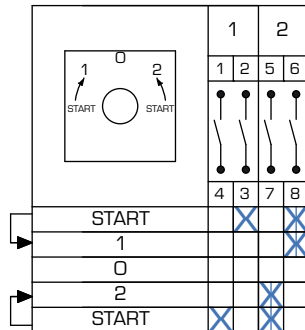

GENERATOR SHORE SELECTOR SWITCH : 4 positions Stayput.

Circuit Arrangement n° **S404_07**

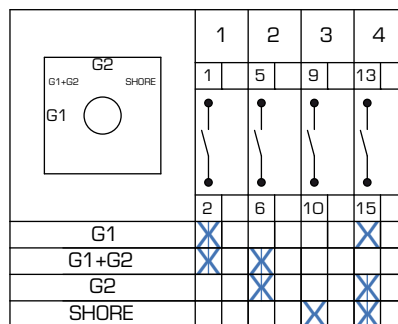

GANG SWITCH : 3 Positions Stayput 1 pole 0 - A - A+B.

Circuit Arrangement n° **S302_74**

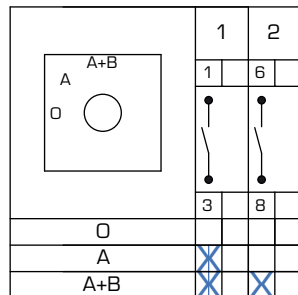

GANG SWITCH : 4 positions stayput 1 pole 0 - A - B - A+B

Circuit Arrangement n° **S302_75**

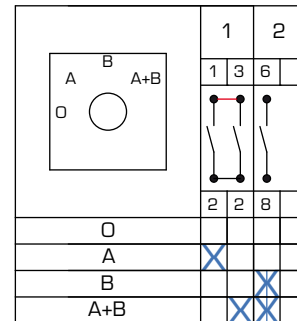

STAR - DELTA SWITCH : 3 positions stayput.

Circuit Arrangement n° **S306_46**

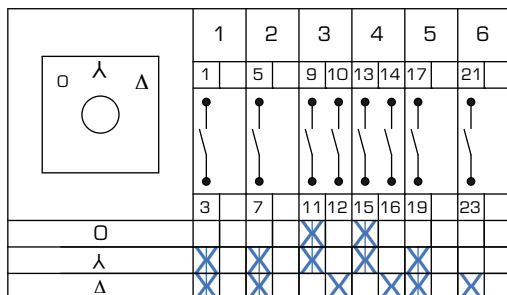

HEATER CONTROL SWITCH : OFF - HIGH - MEDIUM - LOW.

Circuit Arrangement n° **S303_59**

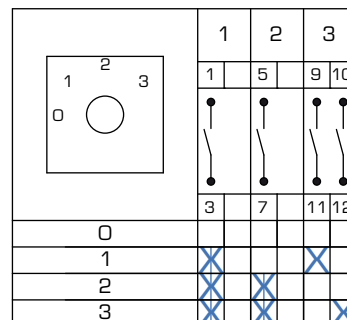

Standard Escutcheon Plate Ordering

The Escutcheon plate is strictly necessary for fitting the switch to the panel, if none engraving is specified, the frontplate will be supplied Blank, code 00000. The engraving listed below, are only a little part of those available, require the code of the needed one if not present.

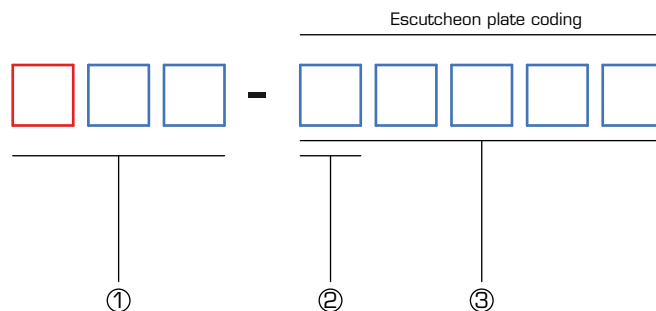

① n° type of the Escutcheon Plate.
 Every switch has its own escutcheon plate. It can be easily found in its drawing or reference catalogue.
 RED code couldn't be present, only for special types.

② n° of Positions.
 First Number of code refers to number of the positions of the switch.

③ 2 Positions

1 O 20002	AUT. MAN. 20004	MAN. AUT. 20006	AUT. MAN. 20007	1 2 O 20008	INCL. ESCL. 20010	DIST. LOC. 20012	2 1 O 20013	REMOTE LOCAL 20016	1 E O 20022	L R O 20028	LOC. REM. O 20030	TE TI O 20035	OFF ON O 20036
R L O 20037	REM. LOC. O 20041	ON OFF O 20050	AUTO O 20054	MAN. O 20055	LOC. DIST. O 20059	OFF ON O 20068	AUT. MAN. SERVIZIO O 20070	PROVA O 20106	LOC. SUPV. O 20187	EMERGENCY NORMAL O 20160	B A O 20065	SHIP SHORE O 20085	HAND AUTO O 20184
PARALLEL INDIVIDUAL O 20116	REM. SUPV. O 20404	MANUAL AUTO O 20231	IN OUT O 20322	TRIP ALARM O 20505	MANUAL AUTO O 20463	SERV. TRIP O 20058	NORMAL TEST O 20138	TR1 TR2 O 20174	ATA ATB O 20196	MAIN A O 20277	WINTER SUMMER O 20289	LOC. SCADA O 20429	OUTBOARD SHORE O 20341
NORMAL TRANSFER O 20346	REM. SUPV. O 20404	GS L O 20161	BYPASS SERVICE O 20510	M A O 20021	O 1 O 20001	OUT IN O 20464	TRIP NORMAL O 20553	DG1 DG2 O 20279	HAND AUTO O 20152	AUTO MANUAL O 20205			

3 Positions

MAN. AUT. O 30003	AUT. MAN. O 30004	M A O 30005	CH. AP O 30010	DM. ALUM. O 30011	AP. CH. O 30012	1 2 O 30013	TEST TRIP O 30014	O 1 2 O 30015	LOC. DIST. O 30016	1 2 3 O 30017	ALUM. DIM. O 30019	OPEN CLOSE O 30024	CLOSE OPEN O 30031
A C B O 30032	START STOP O 30050	TRIP CLOSE O 30052	LOC. REM. O 30057	LOC. AUT. O 30060	2 1 3 O 30082	O MAN. AUT. O 30083	MAN. AUT. O 30084	1 2 O 30385	TRIP CONTROL CLOSE O 30085	TEST STOP O 30086	EM. LOC. REM. O 30078	ON OFF TEST O 30079	RAISE LOWER O 30087
DOS SCADA SCS O 30088	INCR. DECR. O 30089	COLD HEAT O 30090	G1 G2 O 30040	A A/B B O 30047	OFF ON O 30055	L R O 30062	O 1 1+3 O 30172	TRIP NEUTRAL CLOSE O 30120	1 OFF 2 O 30561	RS ST TR O 30630	FY YB BR O 30631	R S T O 30632	R Y B O 30633
TEST LOC. REM. O 30025	A B C O 30114	TEST TRIP N.O. O 30371	AUTO OFF MAN. O 30080	LOWER OFF RAISE O 30113	OUVRE FERMÉ O 30154	LOC. REM. SUPV. O 30165	SHORE OFF GENL. O 30634	IN OUT O 30626	AUTO HAND O 30635	LOC. OFF REM. O 30467	TR1 PARALL. TR2 O 30476	T1 T1+T2 T2 O 30486	MAN. LOC. REM. O 30192
IN NORMAL OUT O 30609	BYPASS CHECK O 30608	O L1 L2 O 30183	S P M O 30526	AUTO MAN. O 30108									

4 Positions

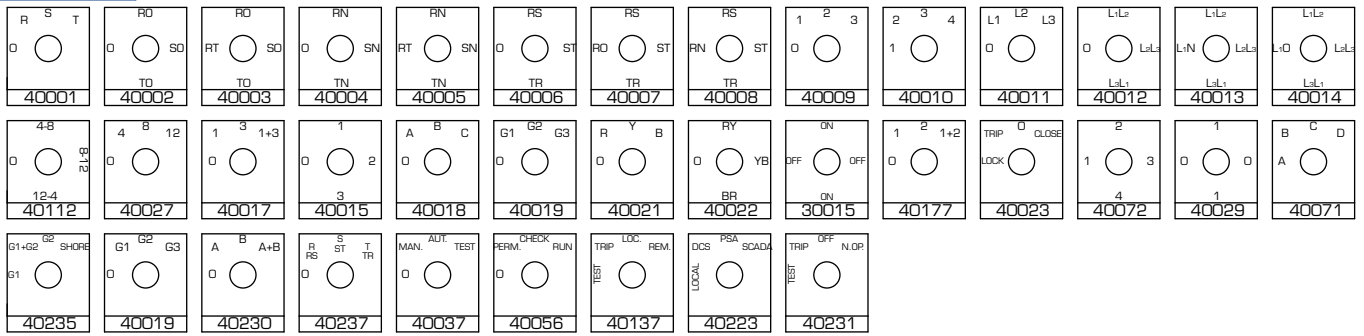

5 Positions

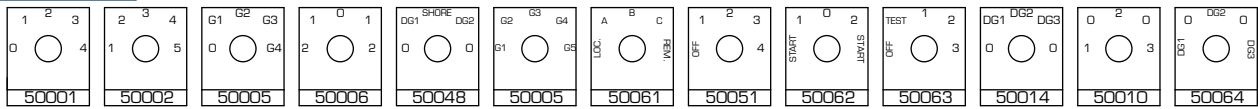

6 Positions

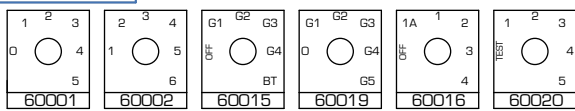

7 Positions

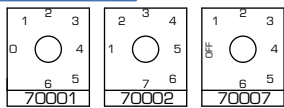

8 Positions

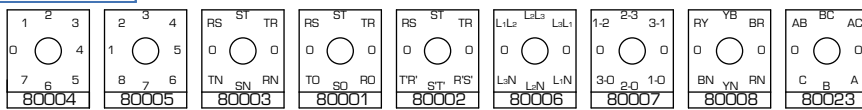

Blank

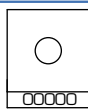

Handle and Escutcheon plate Color

In not any specification is required, the switch is supplied with STANDARD LOOK (black Holder; black handle, black escutcheon plate, white text).

Different colours can be supplied following the table below.

The font used for the text is SWISS 921 BT.

Dimension of letters are proportioned to size of Escutcheon plate.

LOOK N°	Handle	Escutcheon plate	Holder	Text
L1	RED	YELLOW	BLACK	BLACK
L2	RED	BLACK	BLACK	WHITE
L3	BLACK	YELLOW	BLACK	BLACK
L4	RED	RED	RED	WHITE
L5	WHITE	BLACK	BLACK	WHITE
L6	RED	ELECTRO GREY	BLACK	BLACK
L7	BLACK	ELECTRO GREY	BLACK	BLACK
L8	BLACK	GREEN	BLACK	WHITE
L9	BLACK	WHITE	BLACK	BLACK
L10	RED	WHITE	BLACK	BLACK

Locking Programs

The reference line shows where the switch is blocked and the key is withdrawn.

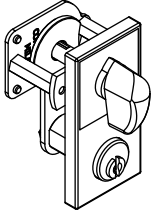
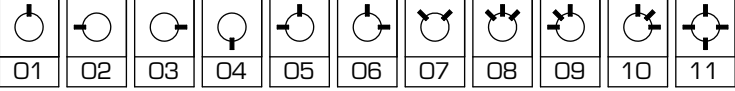
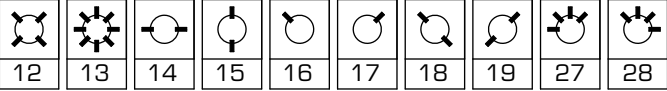
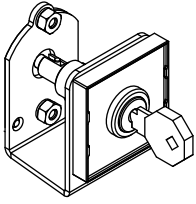
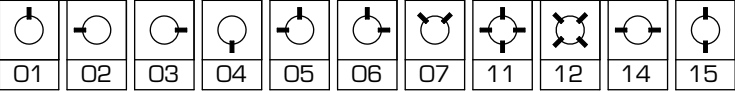
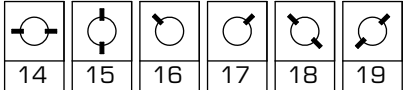
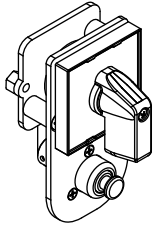
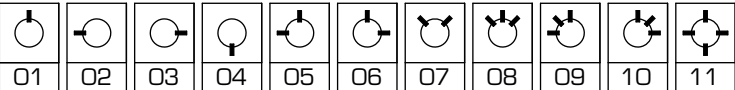
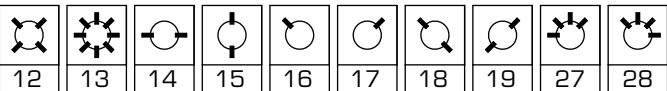
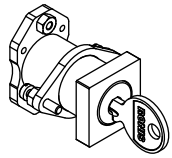
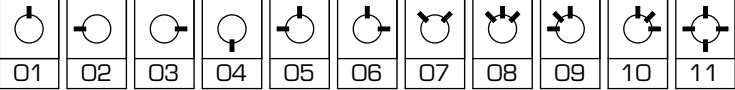
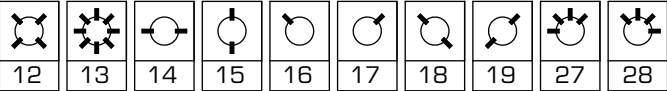
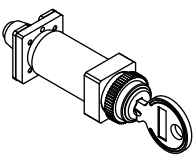
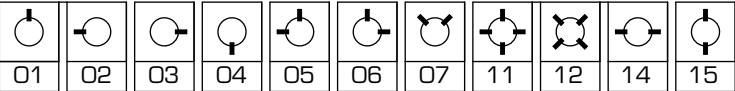
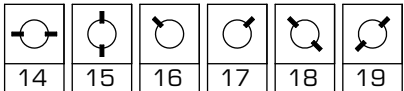
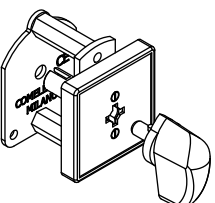
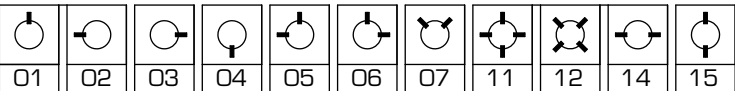
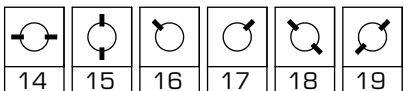
KEY LOCK SWITCH. handle and key separate.	Available in Series	Locking Programs
	FR10: Stayput pos. C103 - C154 - C154P Spring return pos. C115 - C157 - C157P R20: Stayput pos. R103 - R108 - R108B Spring return pos. R125 R16: Stayput pos. R603 Spring return pos. R603M	 
KEY OPERATED SWITCH. Operated directly with the key.	Available in Series	Locking Programs
	FR10: Stayput pos. C161 Spring return pos. C167 R20: Stayput pos. R102 - R162 Spring return pos. R160 R16: Stayput pos. R602 Spring return pos. R602M FRMC 6 IP20: Stayput pos. C704 Spring return pos. C704M	 
PADLOCKABLE SWITCH. Pull the pin and insert the padlock.	Available in Series	Locking Programs
	FR10: Stayput pos. C192L Spring return pos. C192LM R20: Stayput pos. R193L Spring return pos. R193LM R16: Stayput pos. R605 Spring return pos. R605M	 
MINIATURE KEY OPERATED SWITCH. Operated directly with the key	Available in Series	Locking Programs
	FRMC 6: Stayput pos. C602 - C602K - C607 - C609 - C617 - C627V - C627S Spring return pos. C611 FRMC 6 IP20: Stayput pos. C702 - C702K - C713 Spring return pos. C702M	 
MOSAIC MINIATURE KEY OPERATED SWITCH. Operated directly with the key	Available in Series	Locking Programs
	FRMC 2000: Stayput pos. C202 Spring return pos. C204	 
REMOVABLE KNOB SWITCH. The handle can be removed.	Available in Series	Locking Programs
	FR10: Stayput pos. C104 Spring return pos. C104M R20: Stayput pos. R122 - R176 Spring return pos. R122M FRMC 6: Stayput pos. C603 Spring return pos. C603M FRMC 6 IP20: Stayput pos. C701E Spring return pos. C701EM	 

Form for special diagram

Switch Series :

FR10 R20 R16

FRMC 6 FRMC 6 IP20 FRMC 2000

Switch Action :

Stayput Spring return Stayput and Spring return

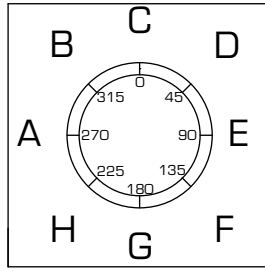

Position Engraving	
Position	Engraving
A	
B	
C	
D	
E	
F	
G	
H	

Specifications

Lock in Pos.	Positions							
	A	B	C	D	E	F	G	H
1								
2								
3								
4								
5								
6								
7								
8								
9								
10								
11								
12								
13								
14								
15								
16								
17								
18								
19								
20								
21								
22								
23								
24								
25								
26								
27								
28								
29								
30								

Model number:

Ordering Code : (it will provided by COMELETIC)

Accessories

Panel Mounting <input type="checkbox"/>	Pistol grip handle <input type="checkbox"/>
Base Mounting <input type="checkbox"/>	Different numbering of keys <input type="checkbox"/>
Gilded Contacts <input type="checkbox"/>	Padlockable facility <input type="checkbox"/>
IP55 Protection <input type="checkbox"/>	Electromechanical interlock <input type="checkbox"/>
Flag Mechanical indicator <input type="checkbox"/> <small>(only for CBCS or spring return switch)</small>	Led position indicator <input type="checkbox"/>

Notes.

Legenda



Closed contact



Closed contact without current breaking



Make before break overlapping contacts (without current breaking).



Maintained action contact (the contact closes in the X pos. and maintained the action for the lenght of the arrow).



Spring return position.



Spring return from left and from right position.



Contact presence.



Terminal marking



Packet indication



Jumpers.
When the connected terminals have the same number , the jumper is internal.



Jumpers.
When the connected terminals have different numbers, the jumper is external and will not be supply by COMELETIC.



The Black strip indicate where the key can be extracted

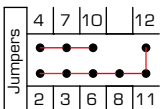

The diagram shows how the switch must be wired to obtain the required function. This jumpers are not be supplied by COMELETIC.